

Trinitron Color TV

Operating Instructions

- Before operating the unit, please read this manual thoroughly and retain it for future reference.

KV-XA29

WARNING

- Dangerously high voltages are present inside the TV.
- TV operating voltage: 110-220 V AC.

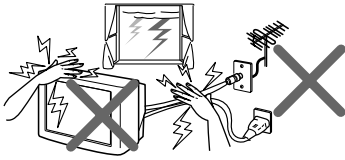

For your own safety, do not touch any part of the TV, the power cord and the antenna cable during lightning storms.



For children's safety, do not leave children alone with the TV. Do not allow children to climb onto it.

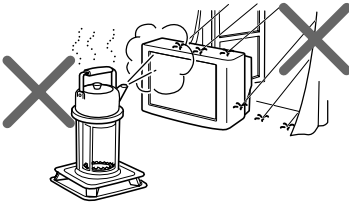

To prevent fire or shock hazard, do not expose the TV to rain or moisture.

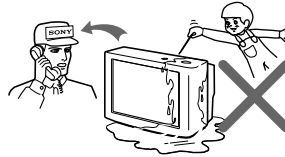

Do not operate the TV if any liquid or solid object falls into it. Have it checked immediately by qualified personnel only.

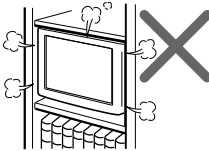

Do not block the ventilation openings of the TV. Do not install the TV in a confined space, such as a bookcase or built-in cabinet.

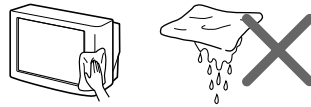

Clean the TV with a dry and soft cloth. Do not use benzine, thinner, or any other chemicals to clean the TV. Do not scratch the picture tube.

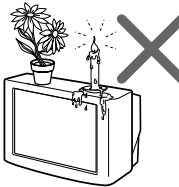

Do not place any objects on the TV.

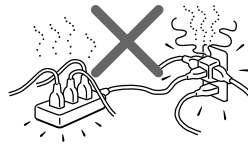

Do not plug in too many appliances to the same power socket. Do not damage the power cord.

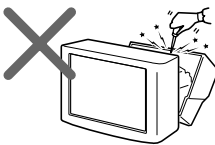

Do not open the cabinet and the rear cover of the TV as high voltages and other hazards are present inside the TV. Refer servicing and disposal of the TV to qualified personnel.

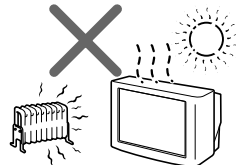

Your TV is recommended for home use only. Do not use the TV in any vehicle or where it may be subject to excessive dust, heat, moisture or vibrations.

Table of Contents

Using Your New TV



Getting Started	4
Step 1: Connect the antenna	4
Step 2: Insert the batteries into the remote	5
Step 3: Preset the channels automatically	5
Connecting optional components	6
Securing the TV	9
Presetting the channels manually	10
Watching the TV	11

Advanced Operations

Selecting the picture and sound modes	14
Viewing your favorite channels	15
Listening with surround sound	16
Enjoying stereo or bilingual programs	17

Adjusting Your Setup (MENU)

Introducing the menu system	18
Changing the "PICTURE" setting 	20

Changing the "SOUND" setting 	22
Changing the "SETUP" setting  ..	24
Changing the Channel Preset ("CH PRESET") setting 	26

Additional Information

Self-diagnosis function	27
Troubleshooting	28
Overview of controls	31
Specifications	Back cover

WARNING (continued)

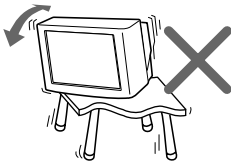

Install the TV on a stable TV stand and floor which can support the TV set weight. Ensure that the TV stand surface is flat and its area is larger than the bottom area of the TV.



Pull the power cord out by the plug. Do not pull the power cord itself. Even if your TV is turned off, it is still connected to the AC power source (mains) as long as the power cord is plugged in. Unplug the TV before moving it or if you are not going to use it for several days.

Getting Started

CAUTION

- Do not connect the power cord until you have completed making all other connections; otherwise a minimum leakage current might flow through the antenna and other terminals to ground.
- To avoid battery leakage and damage to the remote, remove the batteries from the remote if you are not going to use it for several days. If any liquid that leaks from the batteries touches you, immediately wash it away with water.

Step 1

Connect the antenna

If you wish to connect a VCR, see the **Connecting a VCR** diagram below.

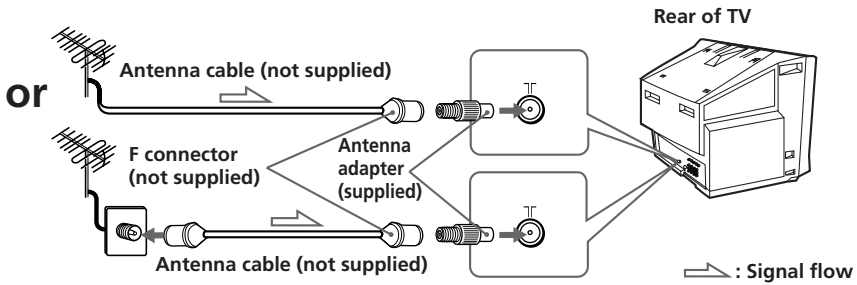

Connecting a VCR

To watch the video input, press VIDEO (see page 12).

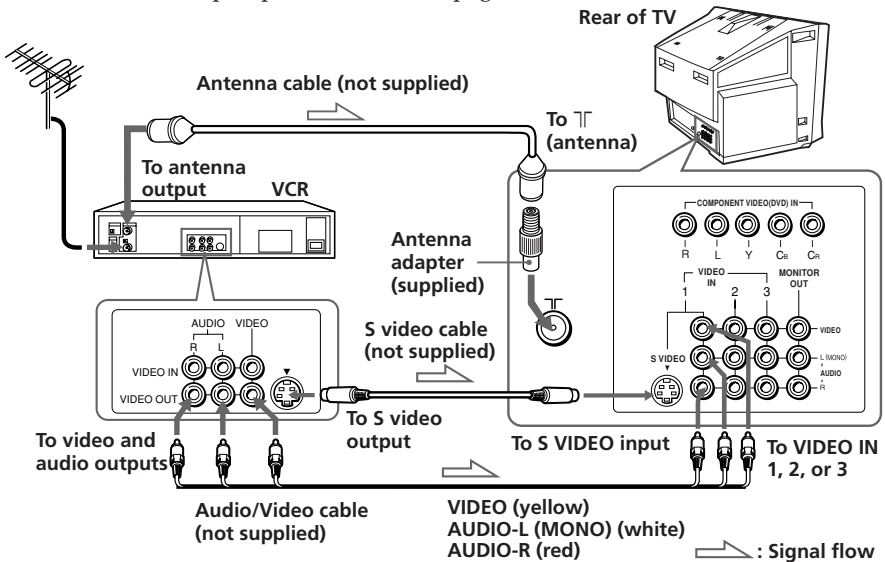

Notes

- If you connect a monaural VCR, connect the yellow plug to VIDEO (the yellow jack) and the black plug to AUDIO-L (MONO) (the white jack).
- If you connect a VCR to the ㄱ (antenna) terminal, preset the signal output from the VCR to the program number 0 on the TV.
- When both the S VIDEO and VIDEO IN 1 input are connected, the S VIDEO input is automatically selected. To view the video input to VIDEO IN 1, disconnect the S video cable.
- Do not connect video equipment to the VIDEO 3 INPUT jacks at the front and VIDEO IN 3 (video input) jack at the rear of your TV at the same time; otherwise the picture will not be displayed properly on the screen.
- When no signal is input from the connected video equipment, the TV screen becomes blue.

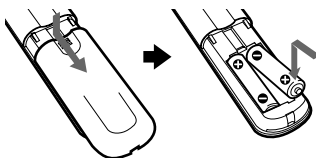
Step 2**Insert the batteries into the remote****Note**

- Do not use old batteries or different types of batteries together.

Step 3**Preset the channels automatically**

Front panel

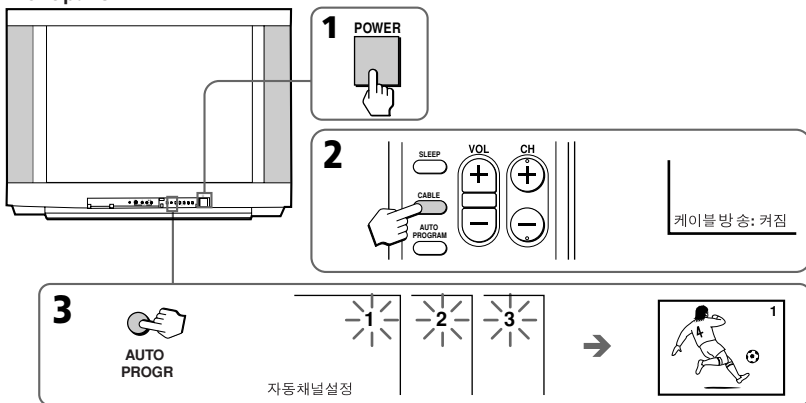
**Tips**

- To stop the automatic channel presetting, press MENU.
- If your TV has preset an unwanted channel or cannot preset a particular channel, then preset your TV manually (see page 10).

Connecting optional components

You can connect optional audio/video components, such as a VCR, multi disc player, DVD, camcorder, video game, or stereo system.

To watch the video input from the connected equipment, press VIDEO (see page 12).

Connecting a camcorder/video game equipment using the VIDEO 3 INPUT jacks

Front of TV

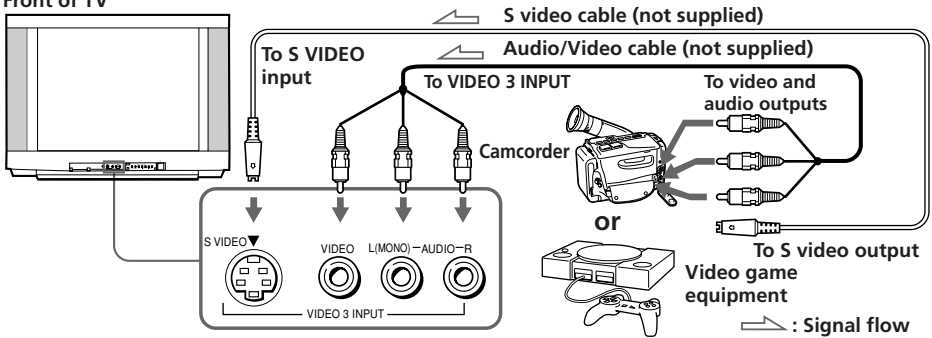

Notes

- When both the S VIDEO input and VIDEO 3 INPUT at the front of your TV are input at the same time, the S VIDEO input is automatically selected. To view the video input to VIDEO 3 INPUT, disconnect the S video cable.
- You can also connect video equipment to the VIDEO IN 1, 2, or 3 jacks at the rear of your TV.
- Do not connect video equipment to the VIDEO 3 INPUT jacks at the front and the VIDEO IN 3 jacks at the rear of your TV at the same time; otherwise the picture will not be displayed properly on the screen.

Connecting audio/video equipment using the MONITOR OUT jacks

Antenna adapter (supplied)

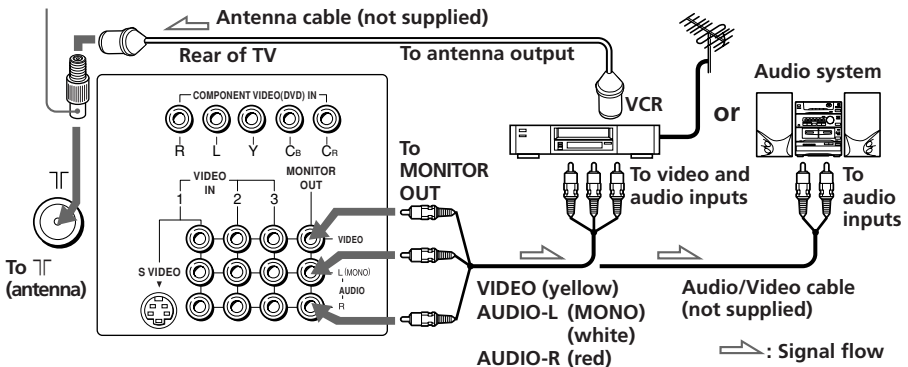

Note

- If you select "DVD" on your TV screen, no signal will be output at the MONITOR OUT jacks (see page 12).

Connecting a DVD player using the VIDEO IN 1, 2 or 3 jacks

Connect VIDEO IN 1, 2 or 3 AUDIO/VIDEO connectors on your TV to LINE OUT on your DVD player.

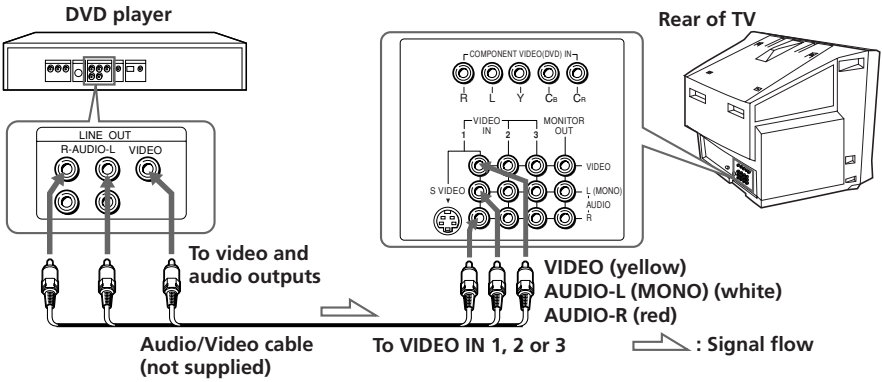

Notes

- Since the high quality pictures on a DVD disc contain a lot of information, picture noise may appear. In this case, adjust the sharpness ("SHARP") under "PERSONAL ADJUST" in the "PICTURE MODE" menu (see page 21).
- Connect your DVD player directly to your TV. Connecting the DVD player through other video equipment will cause unwanted picture noise.

continued

Connecting optional components (continued)

Connecting a DVD player using the COMPONENT VIDEO (DVD) IN jacks

- 1 Using an audio cable, connect R and L under the COMPONENT VIDEO (DVD) IN jacks on your TV to the LINE OUT, AUDIO R and L output connectors on your DVD player.
- 2 Using a component video cable, connect Y, C_B, and C_R under the COMPONENT VIDEO (DVD) IN jacks on your TV to the COMPONENT VIDEO OUT Y, C_B, and C_R output connectors on your DVD player.
- 3 Press VIDEO on the remote or TV/VIDEO on the TV until "DVD" appears on the screen.

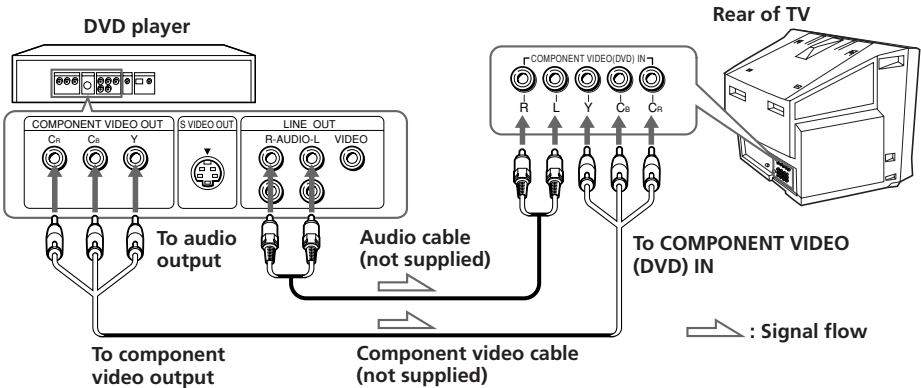

Notes

- If your DVD player can output interlace and progressive mode signals, select the interlace output when connecting to  (component video input) on your TV. Your TV can receive either 525i/60Hz or 625i/50Hz interlace signals.
- Some DVD player terminals may be labeled differently:

Connect	To (on the DVD player)
Y (green)	Y
C _B (blue)	C _b , B-Y or P _B
C _R (red)	C _r , R-Y or P _R

- When connecting to the COMPONENT VIDEO (DVD) IN jacks on your TV, you must connect Y, C_B, and C_R to receive the video signals, and connect L and R to receive analog audio signals.

Securing the TV

To prevent the TV from falling, secure the TV using one of the following methods:

- A** With the supplied screws, attach the stabilizer band to the TV stand and to the rear of the TV using the provided hole.

OR

- B** Put the cord or chain through the clamps to secure the TV against a wall or pillar.

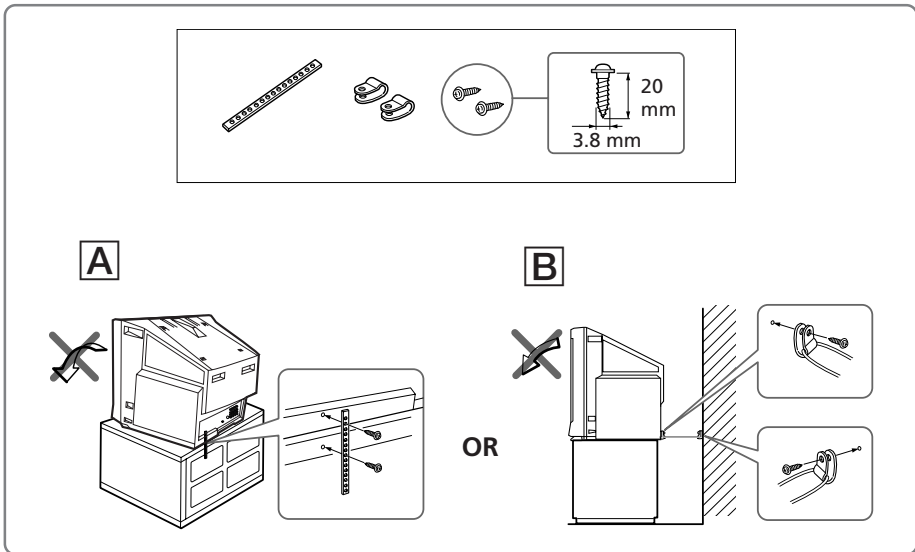

Note

- Use only the supplied screws. Use of other screws may damage the TV.

Presetting the channels manually

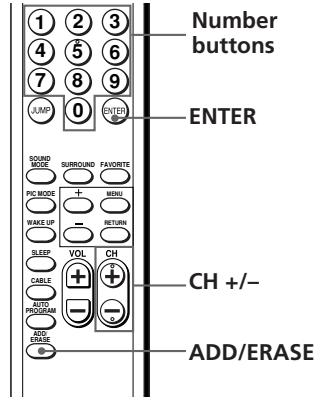

To receive a new channel or a channel with a weak signal, preset the channel manually.

- 1 Press number buttons to select the desired channel number, then press ENTER.

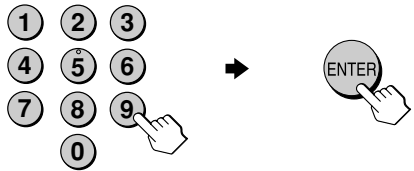

- 2 Press ADD/ERASE.
“+” appears beside the channel number, indicating that presetting is complete.

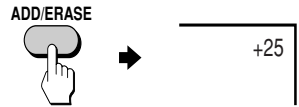

Disabling channel numbers

By disabling unused or unwanted channel numbers, you can skip those channel numbers when you press CH +/-.

- 1 Press CH +/- until the unused or unwanted channel number appears on the screen.

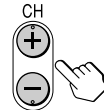

- 2 Press ADD/ERASE.
“-” appears beside the channel number, indicating that disabling is complete.



To cancel the skip setting

Preset the channel again.

Tip

- You can also preset the channels manually using the menu (see **Adjusting each channel number settings (CHANNEL SETUP)** on page 25).

Watching the TV

This section explains various functions and operations available while watching the TV. Most operations can be done using the remote.

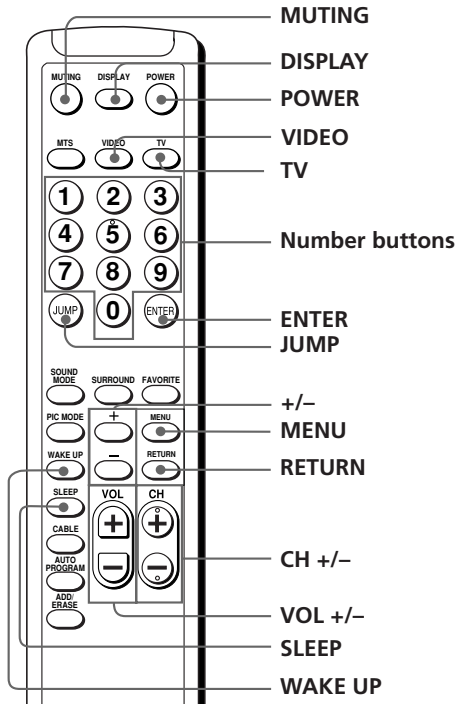
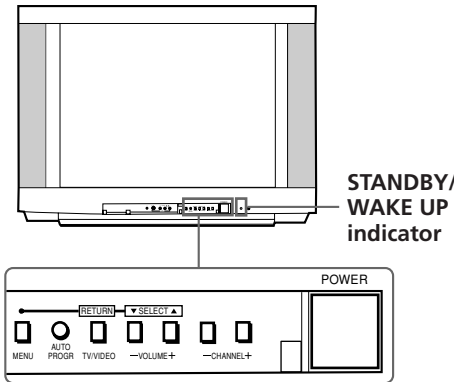

- 1 Press **POWER** on the TV to turn on the TV.
When the TV is in standby mode (the **STANDBY** indicator on the TV is lit red), press **POWER** on the remote or **CHANNEL +/-** on the TV.

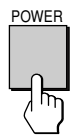

- 2 To select the channel number, press the number buttons and then press **ENTER**, or press **CH +/-**.

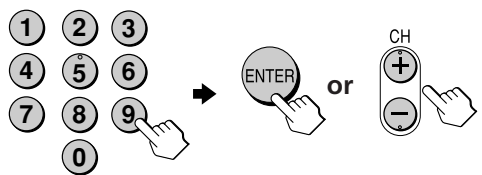

To select a channel number quickly

- (1) Press and hold **CH +/-**.
- (2) Release **CH +/-** when the desired channel number appears.

Note

- When you select a channel number quickly, the picture may be disrupted. This does not indicate a malfunction.

continued

Watching the TV (continued)

Additional tasks

To	Press
Turn off temporarily	POWER on the remote. The STANDBY indicator on the TV lights up red.
Turn off completely	POWER on the TV.
Adjust the volume	VOL +/-.
Mute the sound	MUTING.
Watch the video input (VCR, camcorder, etc.)	VIDEO (or TV/VIDEO on the TV) to select "VIDEO 1", "VIDEO 2", "VIDEO 3" or "DVD". To return to the TV screen, press TV (or TV/VIDEO on the TV).
Jump back to the previous channel number	JUMP.
Display the on-screen information*	DISPLAY.

* Some picture/sound settings, and either the program number or video mode are displayed. The on-screen display for the picture/sound settings disappears after about 3 seconds.

Changing the menu language

You can change the menu language as well as the on-screen language. For details on how to use the menu, see **Introducing the menu system** on page 18.

1 Press MENU.

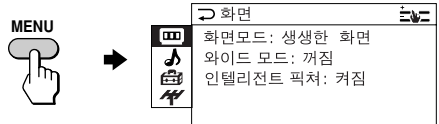

2 Press + or - to select the SETUP icon (), then press RETURN.

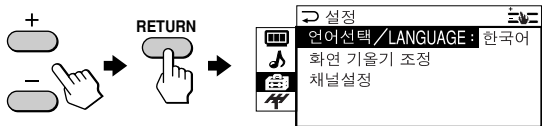

3 Make sure "언어선택 / LANGUAGE" is selected, then press RETURN .

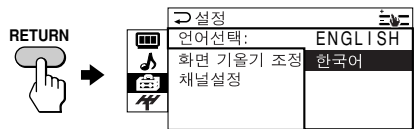

4 Press + or - to select the desired language (e.g., "ENGLISH"), then press RETURN .

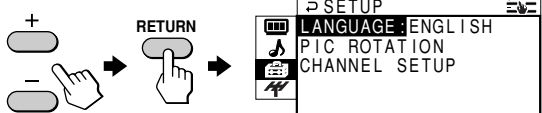

The selected menu language appears.

To return to the normal screen

Press MENU.

Setting the Wake Up timer

- 1 Press WAKE UP until the desired period of time appears.

The Wake Up timer starts immediately after you have set it.

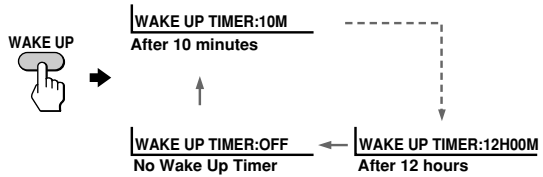

- 2 Select the channel number or video input you want to wake up to.

- 3 Press POWER, or set the Sleep timer if you want the TV to turn off automatically.

The WAKE UP indicator on the TV lights up orange.

To cancel the Wake Up timer

Press WAKE UP until “WAKE UP TIMER: OFF” appears, or turn off the TV’s main power.

Note

- If no buttons or controls are pressed for more than two hours after the TV is turned on using the Wake Up timer, the TV automatically goes into standby mode. To resume watching the TV, press any button or control on the TV or the remote.

Setting the Sleep timer

Press SLEEP until the desired period of time appears.

The Sleep timer starts immediately after you have set it.

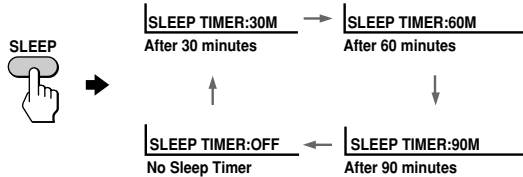

To cancel the Sleep timer

Press SLEEP until “SLEEP TIMER: OFF” appears, or turn the TV off.

Selecting the picture and sound modes

You can select picture and sound modes and adjust the setting to your preference in the "PERSONAL" option.

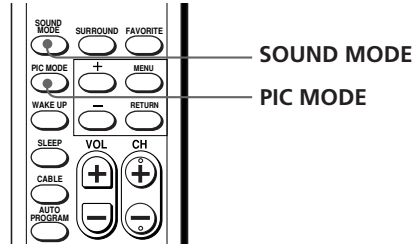

Selecting the picture mode

Press PIC MODE repeatedly until the desired picture mode is selected.

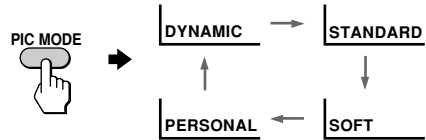

Select	To
"DYNAMIC"	view high contrast pictures.
"STANDARD"	view normal pictures.
"SOFT"	view mild pictures.
"PERSONAL"	receive the last adjusted picture setting from the "ADJUST" option in the "PICTURE" menu (see page 21).

Selecting the sound mode

Press SOUND MODE repeatedly until the desired sound mode is selected.

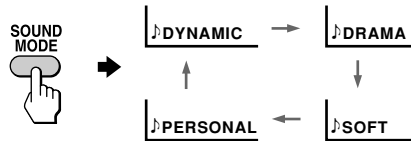

Select	To
"DYNAMIC"	listen to dynamic and clear sound that emphasizes both the low and high tones.
"DRAMA"	listen to sound that emphasizes voice and high tones.
"SOFT"	listen to soft sound.
"PERSONAL"	receive the last adjusted sound setting from the "ADJUST" option in the "SOUND" menu (see page 23).

Tip

- You can also set the picture and sound modes using the menu (see **Changing the "PICTURE" setting** on page 20 and **Changing the "SOUND" setting** on page 22).

Viewing your favorite channels

You can display and select six of your favorite channels directly from your TV screen.

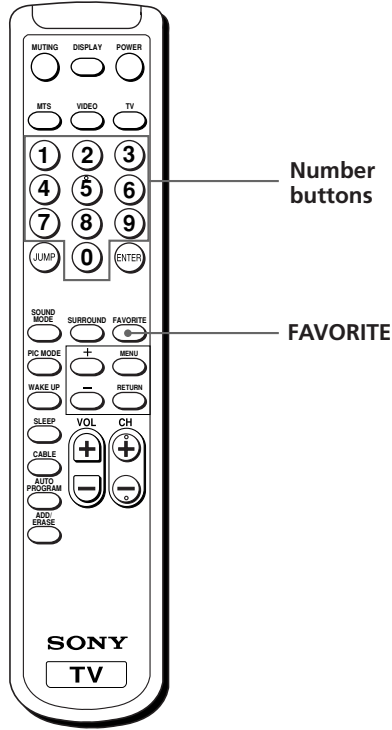

1 Press FAVORITE.

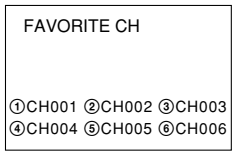

2 Press the number button from 1 to 6 to select the desired favorite channel.

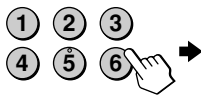

Tip

- To program your favorite channels, see **Adjusting each channel number settings (CHANNEL SETUP)** on page 25.

Listening with surround sound

The surround feature enables you to enjoy the sound effects of a concert hall or movie theater.

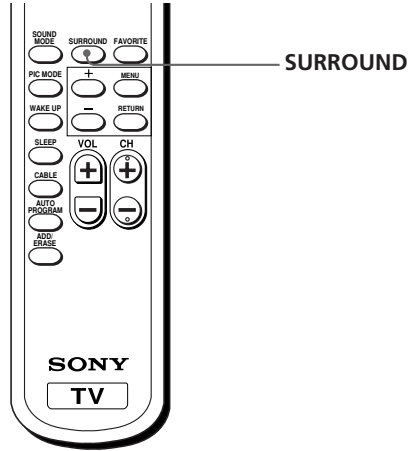

Press SURROUND repeatedly until you receive the desired surround sound.

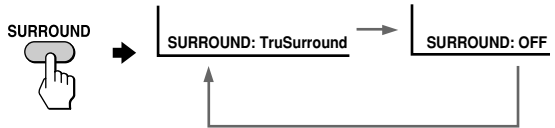

Select	To
"TruSurround"	listen to the surround sound that spreads out to the rear of a room.
"OFF"	turn off the surround sound.

Tip

- You can also select the surround option using the menu (see **Changing the "SOUND" setting** on page 22).

The surround of your TV is categorized as TruSurround.

TruSurround™ is a trademark of SRS Labs, Inc. SRS and the SRS symbol are registered trademarks of SRS Labs, Inc. in the United States and selected foreign countries. SRS and TruSurround are incorporated under license from SRS Labs, Inc. and are protected under United States Patent Nos. 4,748,669 and 4,841,572 with numerous additional issued and pending foreign patents.

Enjoying stereo or bilingual programs

You can enjoy stereo sound or bilingual programs of Korean stereo system.

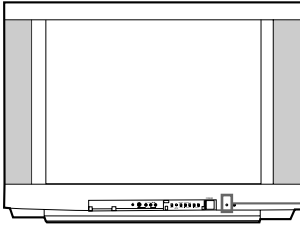

STEREO indicator

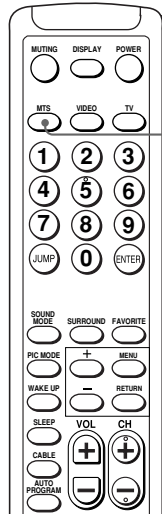

MTS

Press MTS repeatedly until you receive the sound you want.

The on-screen display changes to show the selected sound and the STEREO indicator on the TV lights up red when receiving any stereo or bilingual program.

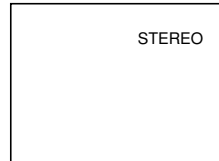

When receiving Korean stereo or bilingual programs

Broadcasting	On-screen display (Selected sound)
Korean stereo	<div style="display: flex; justify-content: space-between; align-items: center;"> <div style="text-align: center;"> <p>MONO (Regular sound)</p> </div> <div style="flex-grow: 1; border-top: 1px solid black; border-bottom: 1px solid black; position: relative;"> <div style="position: absolute; top: -5px; right: -5px;">→</div> </div> <div style="text-align: center;"> <p>STEREO (Stereo sound)</p> </div> </div>
Korean bilingual	<div style="display: flex; justify-content: space-between; align-items: center;"> <div style="text-align: center;"> <p>MAIN (Main sound)</p> </div> <div style="flex-grow: 1; border-top: 1px solid black; border-bottom: 1px solid black; position: relative;"> <div style="position: absolute; top: -5px; right: -5px;">→</div> </div> <div style="text-align: center;"> <p>SUB (Sub sound)</p> </div> </div>





Notes

- If the stereo signal is very weak, the STEREO broadcast sound may become noisy. To reduce the noise, select "MONO".
- You cannot receive a stereo broadcast signal when the TV is in the "MONO" setting.

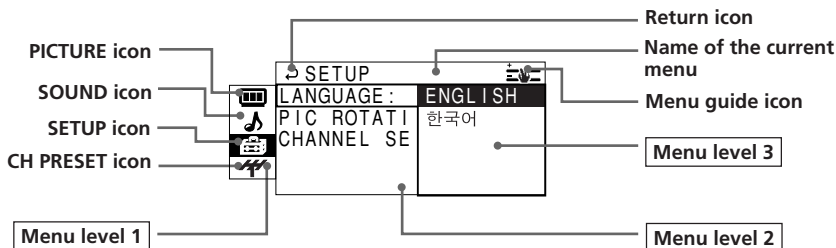
Introducing the menu system

The MENU button lets you open a menu and change the settings of your TV. The following is an overview of the menu system.



Level 1	Level 2	Level 3/Function
"PICTURE" 	"PICTURE MODE"	Select the picture mode: "DYNAMIC" → "STANDARD" → "SOFT" → "PERSONAL" → "ADJUST"
	"ADJUST"	Adjust the "PERSONAL" option: "PICTURE" → "COLOR" → "BRIGHT" → "HUE" → "SHARP"
	"WIDE MODE"	Change the picture size.
	"INTELLIGENT PIC"	Optimize picture quality.
"SOUND" 	"SOUND MODE"	Select the sound mode: "DYNAMIC" → "DRAMA" → "SOFT" → "PERSONAL" → "ADJUST"
	"ADJUST"	Adjust the "PERSONAL" option: "BASS" → "TREBLE" → "BALANCE" → "BBE"*
	"SURROUND"	Select the surround mode: "TruSurround" → "OFF"
	"INTELLIGENT VOL"	Adjust volume automatically.
"SETUP" 	"LANGUAGE"	Change the menu language: "한국어" (Korean) → "ENGLISH"
	"PIC ROTATION"	Adjust the picture position.
	"CHANNEL SETUP"	Adjust each channel number settings.
"CH PRESET" 	"AUTO PROGRAM"	Preset channels automatically.
	"CABLE"	Watch cable TV programs.

* The BBE is manufactured by Sony Corporation under license from BBE Sound, Inc. It is covered by U.S. Patent No. 4,638,258 and No. 4,482,866. The word "BBE" and the BBE symbol are the trademarks of BBE Sound, Inc.

How to use the menu

You can use the buttons on the remote and on the TV as well to display the menu and adjust the settings.

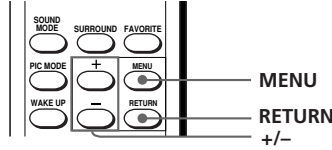

- 1 Press MENU to display the menu.

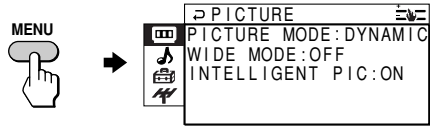

- 2 Press + or - to select the desired item.

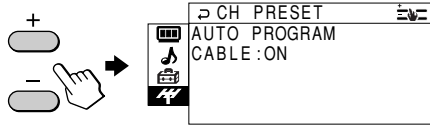

- 3 Press RETURN to confirm your selection and go to the next menu level.

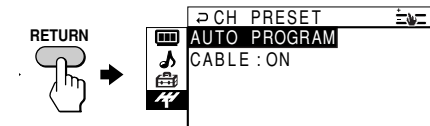

Other menu operations

To	Press
Adjust the setting value	+ or -
Return to the previous menu level	RETURN
Cancel the menu	MENU

Tips

- To return from Menu Level 2 to Menu Level 1, press +/- to select the return icon (↩), then press RETURN.
- Some of the menu items can be operated directly using the remote buttons.
- The MENU, RETURN, and SELECT ▼/▲ buttons on the TV can also be used for the operations above.

Front of TV

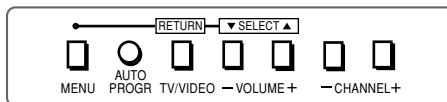

Note

- If more than 60 seconds elapse between entries, the menu screen automatically disappears.

Changing the “PICTURE” setting

The “PICTURE” menu allows you to adjust the picture settings.

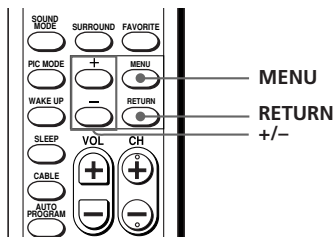

1 Press MENU.

2 Make sure the “PICTURE” icon (📺) is selected, then press RETURN.

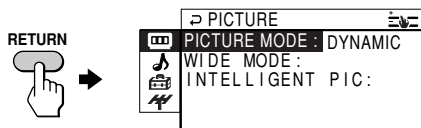

3 Press + or – to select the desired item (e.g., “PICTURE MODE”), then press RETURN.

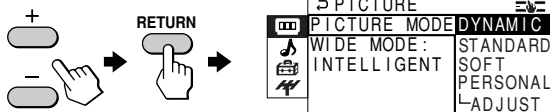

Select	To
“PICTURE MODE”	choose either “DYNAMIC”, “STANDARD”, “SOFT”, “PERSONAL”*, or “ADJUST”.
“WIDE MODE”	change the picture size when receiving wide-mode (16:9) picture signal. Press + or – to select “ON”, then press RETURN. To cancel, select “OFF”, then press RETURN.
“INTELLIGENT PIC”	optimize picture quality. Press + or – to select “ON”, then press RETURN. To cancel, select “OFF”, then press RETURN.

* When the “PERSONAL” mode is selected, you can receive the last adjusted picture settings from the “ADJUST” option (see page 21).

Note

- For details on the options under “PICTURE MODE”, see page 14.

To return to the normal screen

Press MENU.

Adjusting the “ADJUST” items under “PICTURE MODE”

1 Press + or – to select the desired item (e.g., “COLOR”), then press RETURN.

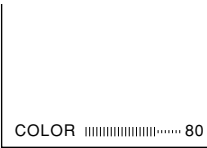
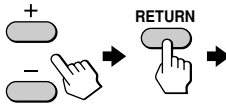

2 Adjust the value according to the following table, then press RETURN.

For	Press – to	Press + to
“PICTURE”	decrease picture contrast	increase picture contrast
“COLOR”	decrease color intensity	increase color intensity
“BRIGHT”	darken the picture	brighten the picture
“HUE”	increase red picture tones	increase green picture tones
“SHARP”	soften the picture	sharpen the picture

3 Repeat the above steps to adjust other items.

The adjusted settings will be received when you select “PERSONAL”.

Tip

- For details on the menu system and how to use the menu, refer to **Introducing the menu system** on page 18.

Changing the "SOUND" setting

The "SOUND" menu allows you to adjust the sound settings.

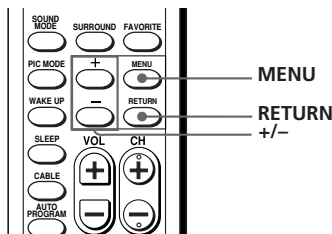

1 Press MENU.

2 Press + or - to select the "SOUND" icon (🔊), then press RETURN.

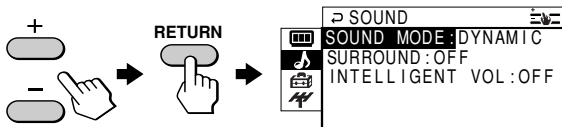

3 Press + or - to select the desired item (e.g., "SOUND MODE"), then press RETURN.

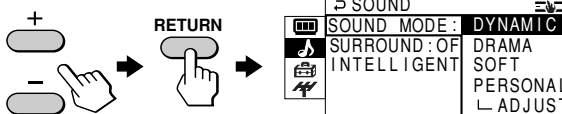

Select	To
"SOUND MODE"	choose either "DYNAMIC", "DRAMA", "SOFT", "PERSONAL"*, or "ADJUST".
"SURROUND"	choose either "TruSurround" or "OFF".
"INTELLIGENT VOL"	adjust the volume of all channel numbers and video inputs automatically. Press + or - to select "ON", then press RETURN. To cancel, select "OFF", then press RETURN.

* When the "PERSONAL" mode is selected, you can receive the last adjusted sound settings from the "ADJUST" option (see page 23).

Note

- For details on the options under "SOUND MODE" and "SURROUND", see pages 14 and 16 respectively.

To return to the normal screen

Press MENU.

Adjusting the “ADJUST” items under “SOUND MODE”

- 1** Press + or – to select the desired item (e.g., “BALANCE”), then press RETURN.

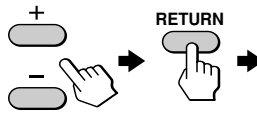

BALANCE  00

- 2** Adjust the value according to the following table, then press RETURN.

For	Press – to	Press + to
“BASS”	decrease the bass.	increase the bass.
“TREBLE”	decrease the treble.	increase the treble.
“BALANCE”	increase the left speaker’s volume.	increase the right speaker’s volume.
“BBE”	select “HIGH” for higher enhancement of sound clarity; select “LOW” for lower enhancement of sound clarity; select “OFF” to turn off the BBE sound.	

- 3** Repeat the above steps to adjust other items.

The adjusted settings will be received when you select “PERSONAL”.

Tip

- For details on the menu system and how to use the menu, refer to **Introducing the menu system** on page 18.

Changing the "SETUP" setting

The "SETUP" menu allows you to change the menu language, adjust the picture position and adjust the channel number settings.

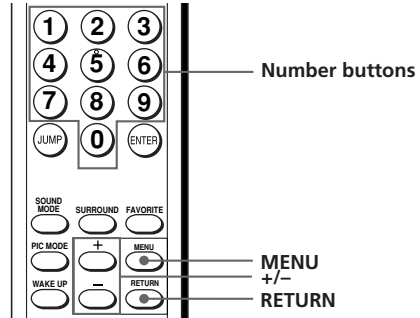

1 Press MENU.

2 Press + or - to select the "SETUP" icon (📺), then press RETURN.

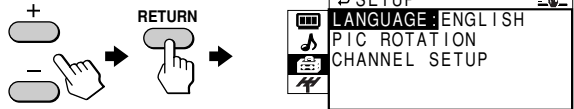

3 Press + or - to select the desired item (e.g., "LANGUAGE"), then press RETURN.

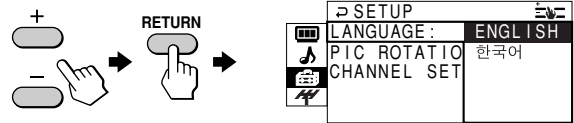

Select	To
"LANGUAGE"	change the menu language (see Changing the menu language on page 12).
"PIC ROTATION"	adjust the picture position when it is not aligned with the TV screen. Press + or - to adjust the picture position, then press RETURN.
"CHANNEL SETUP"	adjust each channel number settings (see Adjusting each channel number settings (CHANNEL SETUP) on page 25).



To return to the normal screen

Press MENU.

Adjusting each channel number settings (CHANNEL SETUP)

1 Select "CHANNEL SETUP" from the "SETUP" menu.

2 Select "CH" and press RETURN. Press + or – to select the desired channel number you want to adjust, then press RETURN.



3 Press + or – to select the desired item (e.g., "ADD/ERASE"), then press RETURN.

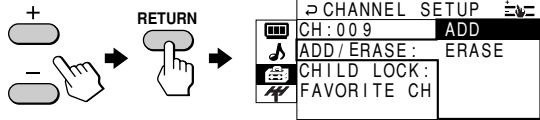

Select	To
"CH"	select the desired channel number.
"ADD/ERASE"	<p>preset the selected channel manually. Press + or – to select "ADD", then press RETURN.</p> <p>To disable an unused or unwanted channel, select "ERASE", then press RETURN.</p> <p>You can also preset channels manually using the ADD/ERASE button on the remote, refer page 10.</p>
"CHILD LOCK"	<p>prevent children from watching this selected channel number. Press + or – to select "ON", then press RETURN.</p> <p>The lock symbol (🔒) appears on the screen. To cancel, select "OFF", then press RETURN.</p> <p>If you automatically preset a locked channel number, that channel number will be unlocked.</p>
"FAVORITE CH"	<p>program six favorite channels for direct selection. Press + or – to select one of the six favorite channel numbers (if you decide not to make any changes, select "↩"), then press RETURN.</p> <p>To view the selected favorite channel, refer page 15.</p>

4 To continue adjusting other channel numbers, press + or – to select "CH", then repeat steps 2 and 3.

To return to the normal screen

Press MENU.

Changing the Channel Preset ("CH PRESET") setting

The "CH PRESET" menu allows you to adjust the setup of your TV to receive either CABLE TV or VHF and UHF broadcast.

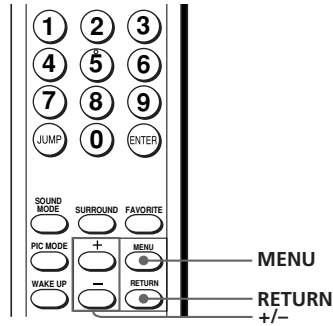

1 Press MENU.

2 Press + or - to select the "CH PRESET" icon (⚡), then press RETURN.

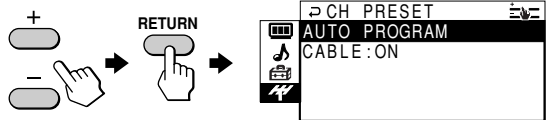

3 Press + or - to select the desired item (e.g., "CABLE"), then press RETURN.

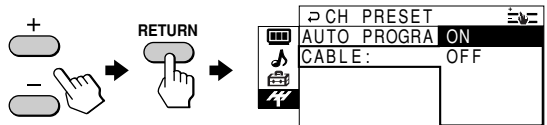

Select	To
"AUTO PROGRAM"	preset channels automatically. If you automatically preset a locked channel number ("CHILD LOCK"), that channel number will be unlocked (see page 25).
"CABLE"	receive cable TV programs. Press + or - to select "ON", then press RETURN. If there is no cable TV program, you will receive the VHF or UHF broadcast channel. To receive only VHF and UHF broadcast channels, select "OFF", then press RETURN.

To return to the normal screen

Press MENU.

Tip

- For details on the menu system and how to use the menu, refer to **Introducing the menu system** on page 18.

Self-diagnosis function

Your TV is equipped with a self-diagnosis function. If there is a problem with your TV, the STANDBY indicator flashes red. The number of times the STANDBY indicator flashes indicates the possible causes.



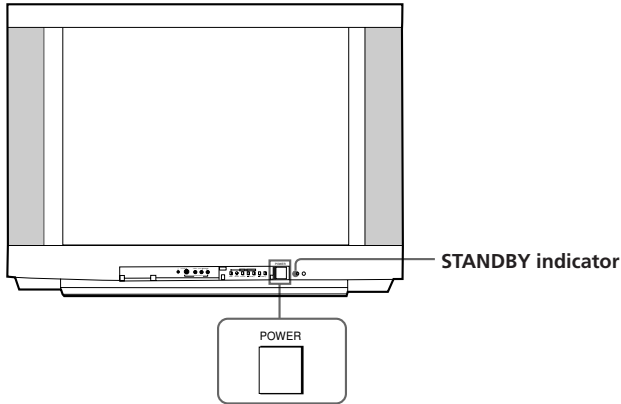



Front of TV



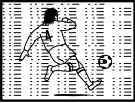





- 1** Check that the STANDBY indicator flashes red a number of times between three second intervals.
- 2** Count the number of times the STANDBY indicator flashes.
- 3** Press POWER to turn off your TV.
- 4** Inform your nearest Sony service center about the number of times the STANDBY indicator flashed.
Be sure to note the model name and serial number located on the rear of your TV.

Troubleshooting



If you find any problem while viewing your TV, please check the following guide. If any problem persists, contact your Sony dealer .

Symptom	Possible cause	Solutions	Page
Snowy picture 	<ul style="list-style-type: none"> • Connection is loose or the cable is damaged. • Channel presetting is inappropriate or incomplete. 	<ul style="list-style-type: none"> • Check the antenna cable and connection on the TV, VCR and on the wall. • Preset the channel again. 	<p>4</p> <p>10</p>
Noisy sound 	<ul style="list-style-type: none"> • The antenna type is inappropriate. • The antenna direction is inappropriate. • Signal transmission is low. 	<ul style="list-style-type: none"> • Check the antenna type ("VHF"/"UHF"). Contact a Sony dealer for advice. • Adjust the antenna direction. Contact a Sony dealer for advice. • Try using a booster. 	<p>–</p> <p>–</p> <p>–</p>
Distorted picture 	<ul style="list-style-type: none"> • Broadcast signals are too strong. 	<ul style="list-style-type: none"> • Turn off or disconnect the booster if it is in use. 	<p>–</p>
Noisy sound 			
No picture 	<ul style="list-style-type: none"> • The power cord, antenna or VCR is not connected. • The TV is not turned on. 	<ul style="list-style-type: none"> • Check the power cord, antenna and the VCR connections. • Press POWER. • Press POWER on the TV to turn off the TV for about five seconds, then turn it on again. 	<p>4</p> <p>11</p> <p>11</p>
No sound 			

Symptom	Possible cause	Solutions	Page
Good picture 	<ul style="list-style-type: none"> The volume level is too low. 	<ul style="list-style-type: none"> Press VOL + or VOLUME + to increase the volume level. 	12
No sound 	<ul style="list-style-type: none"> The sound is muted. 	<ul style="list-style-type: none"> Press MUTING to cancel the muting. 	12
Dotted lines or stripes 	<ul style="list-style-type: none"> There is local interference from cars, neon signs, hair dryers, power generators, etc. 	<ul style="list-style-type: none"> Do not use a hair dryer or other equipment near the TV. Adjust the antenna direction for minimum interference. Contact a Sony dealer for advice. 	—
Double images or "ghosts" 	<ul style="list-style-type: none"> Broadcast signals are reflected by nearby mountains or buildings. 	<ul style="list-style-type: none"> Use a highly directional antenna. 	—
	<ul style="list-style-type: none"> The antenna direction is inappropriate. 	<ul style="list-style-type: none"> Adjust the antenna direction. Contact a Sony dealer for advice. 	—
	<ul style="list-style-type: none"> Use of a booster is inappropriate. 	<ul style="list-style-type: none"> Turn off or disconnect the booster if it is in use. 	—
No color 	<ul style="list-style-type: none"> The color level setting is too low. 	<ul style="list-style-type: none"> Display the "PICTURE" menu and select "ADJUST" of "PICTURE MODE", then adjust the "COLOR" level. 	21
	<ul style="list-style-type: none"> The antenna direction is inappropriate. 	<ul style="list-style-type: none"> Adjust the antenna direction. Contact a Sony dealer for advice. 	—
Abnormal color patches 	<ul style="list-style-type: none"> The magnetic disturbance from external speakers or other equipment, or the direction of the earth's magnetic field may affect the TV. 	<ul style="list-style-type: none"> Keep external speakers or other electrical equipment away from the TV. Do not move the TV while the TV is turned on. Press POWER on the TV to turn off the TV for about five minutes, then turn it on again. 	—
TV cannot receive stereo broadcast signal.	<ul style="list-style-type: none"> The stereo reception setting is inappropriate. 	<ul style="list-style-type: none"> Press MTS until "STEREO" appears on the screen. 	17

continued

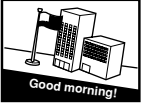
Troubleshooting (continued)

Symptom	Possible cause	Solutions	Page
Stereo broadcast sound switches on and off or is distorted. or The sound switches between monaural and stereo frequently.	• Connection is loose or the cable is damaged.	• Check the antenna cable and connection on the TV, VCR and on the wall.	4
	• The antenna direction is inappropriate.	• Adjust the antenna direction. Contact a Sony dealer for advice.	—
	• Broadcast signal has a transmission problem.	• Press MTS until a better sound is heard.	17
Picture slant 	• The magnetic disturbance from external speakers or other equipment, or the direction of the earth's magnetic field may affect the TV.	• Keep external speakers or other electrical equipment away from the TV. • Display the "SETUP" menu and adjust "PIC ROTATION" until the picture is optimal.	— 24
The  indicator on your TV flashes red a number of times between 3-second intervals.	• Your TV may need service.	• Contact your nearest Sony service center.	27
TV cabinet creaks.	• Changes in room temperature sometimes make the TV cabinet expand or contract, making a noise. This does not indicate a malfunction.	—	—
A "boom" sound is heard when the TV is turned on.	• The TV's demagnetizing function is working. This does not indicate a malfunction.	—	—

Overview of controls

TV front panel

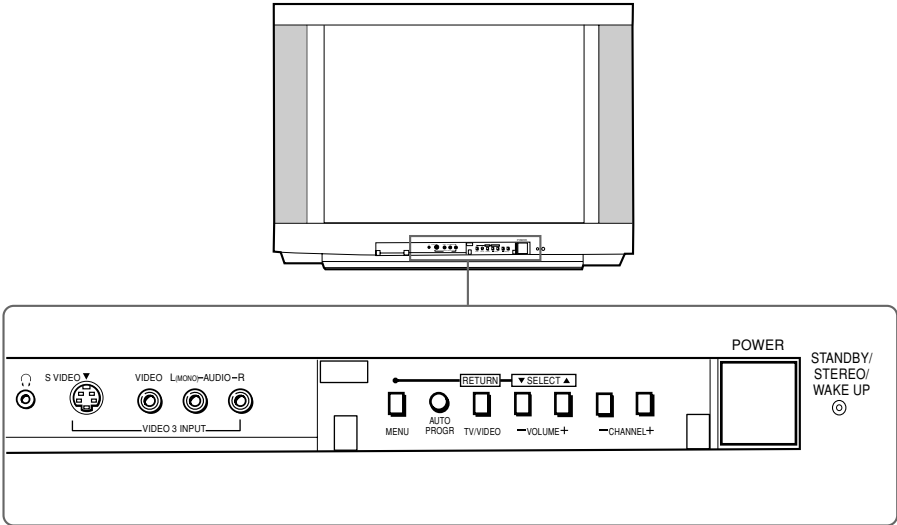

Button	Function	Page
AUTO PROGR	Preset channels automatically.	5
POWER	Turn off completely or turn on the TV.	11
CHANNEL +/-	Select channel number.	11
STANDBY	Standby indicator.	11
VOLUME +/-	Adjust volume.	12
TV/VIDEO	Select TV or video input.	12
WAKE UP	Wake Up indicator.	13
STEREO	Stereo/bilingual indicator.	17
Menu operations		
MENU	Display the menu.	19
SELECT ▼/▲	Select and adjust items.	19
RETURN	Confirm selected items.	19
🎧	Headphone jack.	-

Note

- The TV/VIDEO, CHANNEL +/-, and VOLUME +/- buttons on the TV works as the VIDEO, CH+/-, and VOL +/- buttons respectively on the remote.

continued

Overview of controls (continued)

Remote control

If you prefer Korean labels, you may detach the back of the supplied sticker and attach it on your remote.

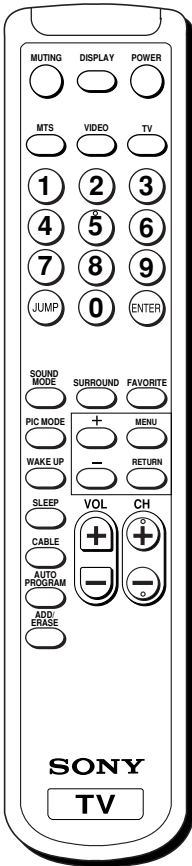

Button	Function	Page
AUTO PROGR	Preset channels automatically.	5
CABLE	Receive cable TV programs.	5
ADD/ERASE	Preset channels manually.	10
0 – 9	Input numbers.	10
ENTER	Confirm input number.	10
POWER	Turn off temporarily or turn on the TV.	11
CH +/-	Select channel number.	11
VOL +/-	Adjust volume.	12
VIDEO	Select TV or video input.	12
TV	Display the TV program.	12
MUTING	Mute the sound.	12
DISPLAY	Display on-screen information.	12
JUMP	Jump to previous channel number.	12
Timer operation		
WAKE UP	Set TV to turn on automatically.	13
SLEEP	Set TV to turn off automatically.	13
PIC MODE	Select picture mode.	14
SOUND MODE	Select sound mode.	14
Favorite Channel operations		
FAVORITE	Display favorite channels.	15
1 – 6	Select desired channel.	15

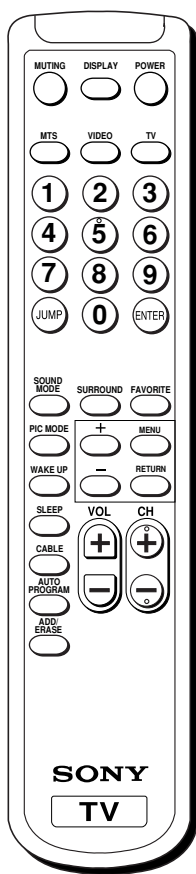

Button	Function	Page
SURROUND	Select surround mode.	16
Stereo/bilingual operations		
MTS	Select stereo/bilingual mode.	17
Menu operations		
MENU	Display the menu.	19
+, -	Select and adjust items.	19
RETURN	Confirm selected items.	19

Specifications

	KV-XA29K90	Note
Power requirements	110-220 V AC, 60 Hz	
Power consumption (W)	Indicated on the rear of the TV	
Television system	M	
Color system	NTSC3.58	
Stereo/Bilingual system	Korean stereo	
Channel coverage	VHF: 2 to 13 UHF: 14 to 69 CATV: 1 to 125	
⌋ (Antenna)	75-ohm external terminal	
Audio output (Speaker)	8W + 8W	
Number of terminal		
VIDEO	Input: 4* Output: 1 Phono jacks; 1 Vp-p, 75 ohms	*Three input lines available
AUDIO	Input: 4* Output: 1 Phono jacks; 500 mVrms	*Three input lines available
S VIDEO	Input: 2 Y: 1 Vp-p, 75 ohms, unbalanced, sync negative C: 0.286 Vp-p, 75 ohms	
COMPONENT VIDEO (DVD) IN	Input: 1 Phono jacks; Y: 1 Vp-p, 75 ohms, sync negative C _B : 0.7 Vp-p, 75 ohms C _R : 0.7 Vp-p, 75 ohms Audio: 500 mVrms	
Ⓜ (Headphone)	Output: 1 Stereo minijack	
Picture tube	29 in.	
Tube size (cm)	72	Measured diagonally
Screen size (cm)	68	Measured diagonally
Dimensions (w/h/d, mm)	772 × 576 × 516	
Mass (kg)	51	

Design and specifications are subject to change without notice.